



Biegeservice

bending service/service cintrage

Seite/page/page 345

Rund-Storeschienen/

round curtain rails/rails ronds de rideaux

Seite/page/page 346



U-Storeschienen/

U-curtain rails/rails de rideaux en U

Seite/page/page 348



Accessoires

accessoires/accessoires

Seite/page/page 352

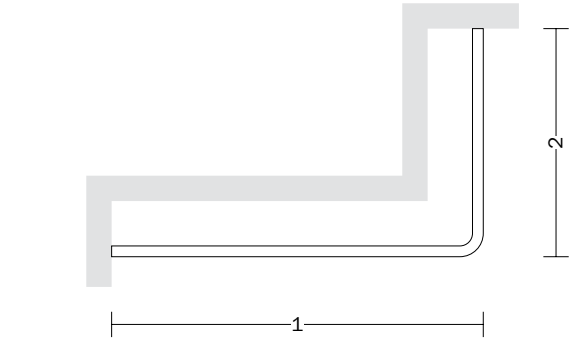

Biegung 90°/90° bend/courbure 90°

Material/material/matériau	ø mm	Radius/rayon	
Messingrohr/brass tube/ tube en laiton	12	10 cm	35,00
Edelstahlrohr/stainless steel tube/ tube en acier inoxydable	12	10 cm	
	16, 20	20 cm	
Aluminumprofil/ aluminum rail/ rail en aluminium	16, 20	10 cm	
	Linea 1000, 2000	10 cm	

Farbe nickel-glanz auf Anfrage/
colour polished nickel on request/couleur nickel brillant sur demande

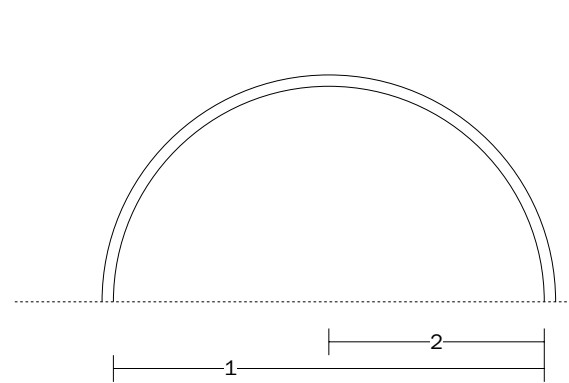

Segmentbogen/semi-circular bend/courbe semi-circulaire

Material/material/matériau	ø mm	Radius/rayon	
Preis pro Meter/price per metre/prix par mètre courant			55,00*
Messingrohr/brass tube/ tube en laiton	12, 16, 20	75 cm	
	25, 28, 30, 35	110 cm	
	40	130 cm	
Stahlrohr/steel tube/tube en acier	16, 20	75 cm	
	28, 35	110 cm	
Edelstahlrohr/stainless steel tube/ tube en acier inoxydable	12, 16, 20	75 cm	
	28	110 cm	
Aluminumprofil/ aluminum rail/ rail en aluminium	20, Linea 2000	75 cm	
	16	110 cm	

Bogen nicht im Radius/bend not within the radius/ne pas courber dans le rayon:
Preis auf Anfrage/price on request/prix sur demande
*Mindestberechnung/minimum charge/facturation minimale: 110,00

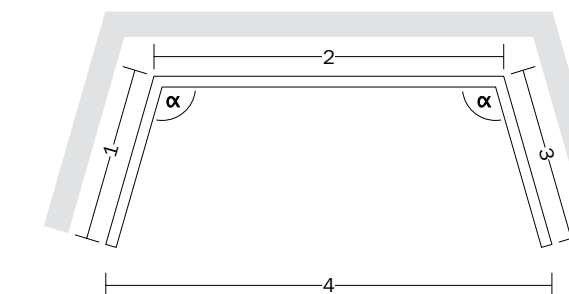

**Erker-/Giebelbogen/
custom-/ceiling bend/arc fer pour le bow-window**

Material/material/matériau	ø mm	Radius/rayon	
Preis pro Biegung/price per bend/prix par courbure			35,00
Messingrohr/brass tube/ tube en laiton	12	10 cm	
Edelstahlrohr/stainless steel tube/ tube en acier inoxydable	12	10 cm	
	16, 20	20 cm	
Aluminumprofil/ aluminum rail/ rail en aluminium	16, 20	10 cm	
	Linea 1000, 2000	10 cm	



**Giebelbogen-Seitenansicht/
side view of ceiling bend/vue latérale de courbure en saillie**

Material/material/matériau	ø mm	Radius/rayon	
Preis pro Biegung/price per bend/prix par courbure			35,00
Aluminumprofil/ aluminum rail/ rail en aluminium	16, 20	10 cm	
	Linea 1000	10 cm	

weitere Biegungen auf Anfrage/further bends on request/ultérieures courbures sur demande

Biege-Maßtoleranzen +/- 1 cm

Die Ziffern zeigen an, welche Maße (in cm) zur Bestellung erforderlich sind. Die Angabe des Wandabstandes in cm ist unbedingt erforderlich. Biegungen (außer 90°) fertigen wir ausschliesslich nach verbindlicher Zeichnung oder Schablone an. Die Mindestradien der einzelnen Rohre/Profile müssen beachtet werden, bei Biegungen über 5/6m muß die Teilung angegeben werden. Alle Biegungen sind Einzelanfertigungen und können nicht zurückgenommen werden. Gebogene Rohre und Profile bedürfen einer besonderen Art der Verpackung bei Versand. Diese Anwendungen werden gesondert zu Selbstkosten berechnet.

Dimensional bending-tolerances +/- 1 cm

The figures indicate the dimensions (in cm) required when ordering. It is essential that the wall distance is quoted in centimetres. We produce curvatures (except of 90°) exclusively according to a binding drawing or template. Consideration must be given to the minimum radii of the individual tubes/profiles and the scale division must be quoted for curvatures of more than 5/6 m. All curvatures are of individual manufacture and can not be returned. Curved tubes and profiles require special packing for despatch. This will be charged for separately at cost price.

Tolérances dimensionnelles de cintrage +/- 1 cm

Les chiffres indiquent les dimensions (en cm) nécessaires pour passer la commande. L'écart mural en cm doit absolument être mentionné. Nous confectionnons exclusivement les cintrages (sauf 90°) à l'appui de dessins définitifs ou de modèles. Les rayons minimaux des différents tubes / profilés doivent être respectés, pour les cintrages supérieurs à 5 / 6 m, la division doit être indiquée. Tous les cintrages sont fabriqués sur commande et ne peuvent pas être repris. Les tubes et profilés cintrés nécessitent un emballage spécial pour l'expédition. Ces charges seront facturées séparément du prix de revient.

U-Storeschienen/U-curtain rails/rails de rideaux en U

accessoires/accessories/accessoires

Endstücke/finials/embouts: Kunststoff/plastic/plastique
Rollen mit Flh/runners with PH/rouleurs avec CP: Kunststoff/plastics//plastique
Schienenhalter/railholder/portes de rail: Kunststoff/plastic/plastique
U-Profil/U profiles/profilés en U: Aluminium/aluminium/aluminium



U-Storeschiene

01 06603
 nickel-glanz
 polished nickel
 nickel brillant



U-Storeschiene

01 06601
 messing-glanz
 polished brass
 laiton brillant



U-Storeschiene

01 06605
 weiss
 white
 blanc



U-Storeschiene

01 06607
 brüniert
 browned
 bruni



U-Storeschiene

01 06609
 beige
 beige
 beige

Artikelnummerschlüssel/article number key/clé numéro d'article

1+2+3/4

- 1 Endstück/finial/embout **01...**
- 2 Träger/brackets/supports **01 06...**
- 3 Farbe/colour/couleur **01 06601**
- 4 Länge/length/longueur **01 06601/100 cm**

1
 Endstück/finial/embout **01...**
 U-Storeschienen/U-curtain rails/rails de rideaux en U







2
 Träger/brackets/supports **...06...**

3 Farbe/colour/couleur	messing-glanz/polished brass/laiton brillant	...601	
	nickel-glanz/polished nickel/nickel brillant	...603	
	weiss/white/blanc		...605
	brüniert/browned/bruni		...607
	beige/beige/beige		...609



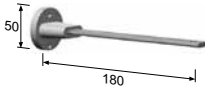
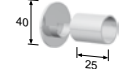





1-läufig/single/simple					
4 Länge/length/longueur	100	18	2	12,00	11,00
	120	21	2	14,00	13,00
	140	24	2	15,00	14,00
	160	27	2	17,00	16,00
	180	30	2	19,00	17,00
	200	34	2*	21,00	19,00
	220	37	2*	22,00	21,00
	240	40	3	25,00	23,00
	260	43	3	27,00	24,00
	280	46	3	28,00	26,00
	300	50	3	30,00	28,00
	320	53	3	32,00	29,00
	340	56	3	33,00	31,00
	360	59	3	35,00	32,00
	380	62	3	37,00	34,00
	400	66	3*	39,00	35,00
420	69	3*	40,00	37,00	
440	72	3*	42,00	38,00	
460	75	3*	44,00	40,00	
480	78	3*	45,00	41,00	
500	82	3*	47,00	43,00	
Je weitere 20 cm, 4 Rollen/every additional 20 cm, 4 runners/ tous les 20 cm supplémentaires, 4 rouleurs				+	2,00 2,00

*Bis ca. 180 cm freitragend, ab 200/400 cm wird 1 Storeschienen-Zwischenträger empfohlen.
 *An additional centre support is recommended for lengths over 200 cm as well as lengths over 400 cm.
 *Un support supplémentaire est recommandé pour les longueurs supérieures à 200 cm et celles dépassant 400 cm

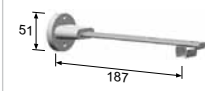





Rund-Storeschienen/round curtain rails/rails ronds de rideaux







	Endkappe/end cap/embout	messing/brass/laiton	89 36401	1,60
		nickel/nickel/nickel	89 36403	1,60
		weiss/white/blanc	89 36405	1,60
	Schienehalter/rail holder/porte de rail	messing/brass/laiton	89 55401	1,20
		nickel/nickel/nickel	89 55403	1,20
		weiss/white/blanc	89 55405	1,20
	Storeschienen-Zwischenträger/center bracket for curtain rail/support intermédiaire pour rail de rideau	messing/brass/laiton	89 26401	8,50
		nickel/nickel/nickel	89 26403	8,50
		weiss/white/blanc	89 26405	8,50
	Wandrosette/rod socket/naissance	messing-glanz/polished brass/laiton brillant	89 45601	22,00
		nickel-glanz/polished nickel/nickel brillant	89 45603	20,00
		silber/silver/argent	89 45604	20,00
		weiss/white/blanc	89 45605	20,00
	Clickgleiter mit Faltenleghaken/click slide with pleating hook/glisser à pression avec crochet de plissage	weiss/white/blanc	89 05405	0,22
	Gleiter mit Faltenleghaken/slide with pleating hook/glisser avec crochet de plissage	weiss/white/blanc	89 04405	0,09
	Gleiter mit Oesenhaken/slide with eyelet hook/glisser avec crochet à œillets	weiss/white/blanc	89 01405	0,09
	Doppelhaken/insert for eyelet hook/crochet double	weiss/white/blanc	624 65405	0,10
	Zwischenfeststeller/centre stop/arrêt intermédiaire	weiss/white/blanc	89 75405	0,50
	Rundprofil/round profile/profilé rond			
	Zuschnitt/cut-to-measure length/coupe sur mesure	messing-glanz/polished brass/laiton brillant	89 12601	28,00*
		nickel-glanz/polished nickel/nickel brillant	89 12603	26,00*
		silber/silver/argent	89 12604	26,00*
		weiss/white/blanc	89 12605	26,00*
	Originallänge/standard length/longueur standard 6 m	messing-glanz/polished brass/laiton brillant	89 1260160	25,20*
		nickel-glanz/polished nickel/nickel brillant	89 1260360	23,40*
		silber/silver/argent	89 1260460	23,40*
	weiss/white/blanc	89 1260560	23,40*	

U-Storeschienen/U-curtain rails/rails de rideaux en U





	Endkappe/end cap/embout	messing/brass/laiton	01 36401	0,45
		nickel/nickel/nickel	01 36403	0,45
		weiss/white/blanc	01 36405	0,45
		beige/beige/beige	01 36409	0,45
		braun/brown/brun	01 36411	0,45
	Schienehalter/rail holder/porte de rail	messing/brass/laiton	01 55401	0,90
		nickel/nickel/nickel	01 55403	0,90
		weiss/white/blanc	01 55405	0,90
		beige/beige/beige	01 55409	0,90
		braun/brown/brun	01 55411	0,90
	Storeschienen-Zwischenträger/center bracket for curtain rail/support intermédiaire pour rail de rideau	messing/brass/laiton	01 26401	12,00
		nickel/nickel/nickel	01 26403	12,00
		weiss/white/blanc	01 26405	12,00
		beige/beige/beige	01 26409	12,00
		braun/brown/brun	01 26411	12,00
	Wandlager/rail socket/naissance	messing/brass/laiton	01 45401	5,50
		nickel/nickel/nickel	01 45403	5,50
		weiss/white/blanc	01 45405	5,50
		beige/beige/beige	01 45409	5,50
		braun/brown/brun	01 45411	5,50
	Rolle mit Faltenleghaken/roll with pleating hook/rouleur avec crochet de plissage	weiss/white/blanc	01 04405	0,22
	Rolle mit Oese/roll with eyelet hook/rouleur avec crochet à œillets	weiss/white/blanc	01 01405	0,22
	Doppelhaken/insert for eyelet hook/crochet double	weiss/white/blanc	624 65405	0,10
	U-Profil/U profile/profilé en U			
	Zuschnitt/cut-to-measure length/coupe sur mesure	messing-glanz/polished brass/laiton brillant	01 12601	5,00*
		nickel-glanz/polished nickel/nickel brillant	01 12603	5,00*
		weiss/white/blanc	01 12605	4,20*
		brüniert/browned/bruni	01 12607	4,20*
		beige/beige/beige	01 12609	4,20*
	Originallänge/standard length/longueur standard 5 m	messing-glanz/polished brass/laiton brillant	01 1260150	4,50*
		nickel-glanz/polished nickel/nickel brillant	01 1260350	4,50*
	weiss/white/blanc	01 1260550	3,80*	
	brüniert/browned/bruni	01 1260750	3,80*	
	beige/beige/beige	01 1260950	3,80*	

* Preis pro laufender Meter/price per running metre/prix par mètre courant

Opus	Raffrosette/holdback/rosette de drapage			
	8 cm	messing-glanz/polished brass/laiton brillant	382 80201	75,00
		messing-matt/brushed brass/laiton mat	382 80202	75,00
		nickel-glanz/polished nickel/nickel brillant	382 80203	78,00
		edelstahl/stainless steel/acier inoxydable	382 80661	78,00
	22 cm	messing-glanz/polished brass/laiton brillant	382 84201	90,00
		messing-matt/brushed brass/laiton mat	382 84202	90,00
	nickel-glanz/polished nickel/nickel brillant	382 84203	94,00	
	edelstahl/stainless steel/acier inoxydable	382 84661	94,00	
Gaia	Raffrosette/holdback/rosette de drapage			
	8 cm	messing-matt/brushed brass/laiton mat	362 80202	95,00
		nickel-matt/brushed nickel/nickel mat	362 80204	95,00
		schwarz-brüniert/black gunmetal/noir bruni	362 80206	95,00
	22 cm	messing-matt/brushed brass/laiton mat	362 84202	105,00
		nickel-matt/brushed nickel/nickel mat	362 84204	105,00
		schwarz-brüniert/black gunmetal/noir bruni	362 84206	105,00
Johara	Raffrosette/holdback/rosette de drapage			
	8 cm	messing-matt/brushed brass/laiton mat	363 80202	125,00
		nickel-matt/brushed nickel/nickel mat	363 80204	125,00
		schwarz, altkupfer/black, antique copper/noir, antique cuivre	363 80305	140,00
	22 cm	messing-matt/brushed brass/laiton mat	363 84202	140,00
		nickel-matt/brushed nickel/nickel mat	363 84204	140,00
		schwarz, altkupfer/black, antique copper/noir, antique cuivre	363 84305	150,00
Concav	Raffrosette/holdback/rosette de drapage			
	8 cm	messing-glanz/polished brass/laiton brillant	51 80201	98,00
		messing-matt/brushed brass/laiton mat	51 80202	98,00
		nickel-glanz/polished nickel/nickel brillant	51 80203	110,00
		nickel-matt/brushed nickel/nickel mat	51 80204	110,00
	22 cm	messing-glanz/polished brass/laiton brillant	51 84201	120,00
		messing-matt/brushed brass/laiton mat	51 84202	120,00
		nickel-glanz/polished nickel/nickel brillant	51 84203	135,00
		nickel-matt/brushed nickel/nickel mat	51 84204	135,00
Post-modern	Knopf/finial button/embout button			
	8 cm	messing-glanz/polished brass/laiton brillant	136 80201	80,00
		messing-matt/brushed brass/laiton mat	136 80202	80,00
		nickel-matt/brushed nickel/nickel mat	136 80204	95,00
		altmessing/antique brass/laiton antique	136 80212	95,00
	22 cm	messing-glanz/polished brass/laiton brillant	136 84201	100,00
		messing-matt/brushed brass/laiton mat	136 84202	100,00
		nickel-matt/brushed nickel/nickel mat	136 84204	115,00
		altmessing/antique brass/laiton antique	136 84212	115,00
Post-modern	Kugel/ball-shaped finial/embout boule			
	8 cm	messing-glanz/polished brass/laiton brillant	137 80201	80,00
		messing-matt/brushed brass/laiton mat	137 80202	80,00
		nickel-matt/brushed nickel/nickel mat	137 80204	95,00
		altmessing/antique brass/laiton antique	137 80212	95,00
	22 cm	messing-glanz/polished brass/laiton brillant	137 84201	100,00
		messing-matt/brushed brass/laiton mat	137 84202	100,00
		nickel-matt/brushed nickel/nickel mat	137 84204	115,00
		altmessing/antique brass/laiton antique	137 84212	115,00

Shanghai	Raffrosette/holdback/rosette de drapage			
	8 cm	messing-matt, rot/brushed brass, red/laiton mat, rouge	360 85110	175,00
		messing-matt, elfenbein/brushed brass, ivory/laiton mat, ivoire	360 85113	175,00
		messing-matt, ebenholz/brushed brass, ebony/laiton mat, ébène	360 85114	175,00
		nickel-matt, rot/brushed nickel, red/nickel mat, rouge	360 85116	175,00
		nickel-matt, elfenbein/brushed nickel, ivory/nickel mat, ivoire	360 85119	175,00
		nickel-matt, ebenholz/brushed nickel, ebony/nickel mat, ébène	360 85120	175,00
	22 cm	messing-matt, rot/brushed brass, red/laiton mat, rouge	360 86110	185,00
		messing-matt, elfenbein/brushed brass, ivory/laiton mat, ivoire	360 86113	185,00
		messing-matt, ebenholz/brushed brass, ebony/laiton mat, ébène	360 86114	185,00
		nickel-matt, rot/brushed nickel, red/nickel mat, rouge	360 86116	185,00
		nickel-matt, elfenbein/brushed nickel, ivory/nickel mat, ivoire	360 86119	185,00
		nickel-matt, ebenholz/brushed nickel, ebony/nickel mat, ébène	360 86120	185,00
Atlanta	Raffrosette/holdback/rosette de drapage			
	8 cm	messing-glanz/polished brass/laiton brillant	157 80201	65,00
		messing-matt/brushed brass/laiton mat	157 80202	65,00
		nickel-glanz/polished nickel/nickel brillant	157 80203	80,00
		nickel-matt/brushed nickel/nickel mat	157 80204	80,00
	22 cm	messing-glanz/polished brass/laiton brillant	157 84201	85,00
		messing-matt/brushed brass/laiton mat	157 84202	85,00
		nickel-glanz/polished nickel/nickel brillant	157 84203	95,00
		nickel-matt/brushed nickel/nickel mat	157 84204	95,00
Sevilla	Raffrosette/holdback/rosette de drapage			
	8 cm	messing-glanz/polished brass/laiton brillant	159 80201	65,00
		messing-matt/brushed brass/laiton mat	159 80202	65,00
		nickel-glanz/polished nickel/nickel brillant	159 80203	80,00
		nickel-matt/brushed nickel/nickel mat	159 80204	80,00
	22 cm	messing-glanz/polished brass/laiton brillant	159 84201	85,00
		messing-matt/brushed brass/laiton mat	159 84202	85,00
		nickel-glanz/polished nickel/nickel brillant	159 84203	95,00
		nickel-matt/brushed nickel/nickel mat	159 84204	95,00
Rialto	Raffrosette/holdback/rosette de drapage			
	8,5 cm	messing-glanz/polished brass/laiton brillant	165 80201	40,00
Directoire	Raffrosette/holdback/rosette de drapage			
	8,5 cm	messing-glanz/polished brass/laiton brillant	196 80201	35,00
		messing-matt/brushed brass/laiton mat	196 80202	35,00
		nickel-glanz/polished nickel/nickel brillant	196 80203	42,00
		nickel-matt/brushed nickel/nickel mat	196 80204	42,00
		schwarz-brüniert/black gunmetal/noir bruni	196 80206	48,00
		bronze-antik/antique bronze/bronze antique	196 80371	48,00
Louis XV	Raffrosette/holdback/rosette de drapage			
	8,5 cm	messing-glanz/polished brass/laiton brillant	194 80201	35,00
		messing-matt/brushed brass/laiton mat	194 80202	35,00
		nickel-glanz/polished nickel/nickel brillant	194 80203	42,00
		nickel-matt/brushed nickel/nickel mat	194 80204	42,00
		schwarz-brüniert/black gunmetal/noir bruni	194 80206	48,00
		bronze-antik/antique bronze/bronze antique	194 80371	48,00

	Sulis Raffrosette/holdback/rosette de drapage			
	8 cm	messing-glanz/polished brass/laiton brillant	681 80201	40,00
		messing-matt/brushed brass/laiton mat	681 80202	40,00
		nickel-glanz/polished nickel/nickel brillant	681 80203	48,00
		nickel-matt/brushed nickel/nickel mat	681 80204	48,00
		schwarz-brüniert/black gunmetal/noir bruni	681 80206	52,00
		bronze-antik/antique bronze/bronze antique	681 80371	52,00
	Distanzstück/extension/extension			
	8,5 cm	messing-glanz/polished brass/laiton brillant	193 89201	12,00
		messing-matt/brushed brass/laiton mat	193 89202	12,00
		nickel-glanz/polished nickel/nickel brillant	193 89203	15,00
		nickel-matt/brushed nickel/nickel mat	193 89204	15,00
		schwarz-brüniert/black gunmetal/noir bruni	193 89206	15,00
		bronze-antik/antique bronze/bronze antique	193 89371	15,00
	Matronen Raffrosette/holdback/rosette de drapage			
	8 cm	messing-glanz/polished brass/laiton brillant	682 80201	50,00
		messing-matt/brushed brass/laiton mat	682 80202	50,00
		nickel-glanz/polished nickel/nickel brillant	682 80203	60,00
		nickel-matt/brushed nickel/nickel mat	682 80204	60,00
	22 cm	messing-glanz/polished brass/laiton brillant	682 84201	65,00
		messing-matt/brushed brass/laiton mat	682 84202	65,00
		nickel-glanz/polished nickel/nickel brillant	682 84203	75,00
		nickel-matt/brushed nickel/nickel mat	682 84204	75,00
	Garda Raffband Leder/tieback leather/embrasse en cuir			
	72 cm	schwarz/black/noir	501 73804	145,00
		natur/natural/naturel	501 73823	145,00
		caramel/caramel/caramel	501 73831	145,00
		bulgar-rot/bulgar red/bulgar rouge	501 73832	145,00
	Oasi Raffband Leder geflochten/tieback leather plaited/embrasse en cuir tressé			
	72 cm	schwarz/black/noir	504 73804	145,00
	Raffbügel/drapery holdback/cintre de drapage			
		messing-glanz/polished brass/laiton brillant	49 72201	95,00
		messing-matt/brushed brass/laiton mat	49 72202	95,00
		nickel-glanz/polished nickel/nickel brillant	49 72203	120,00
		nickel-matt/brushed nickel/nickel mat	49 72204	120,00
	Louis XVI Schalhalter/tieback/embrasse			
	28 x 16 cm	messing-glanz/polished brass/laiton brillant	184 87201	70,00
		messing-matt/brushed brass/laiton mat	184 87202	70,00
		nickel-glanz/polished nickel/nickel brillant	184 87203	85,00
		nickel-matt/brushed nickel/nickel mat	184 87204	85,00
		schwarz-brüniert/black gunmetal/noir bruni	184 87206	90,00
		bronze-antik/antique bronze/bronze antique	184 87371	90,00
	Regency Schalhalter/tieback/embrasse			
	26 x 17 cm	messing-glanz/polished brass/laiton brillant	195 87201	48,00
		messing-matt/brushed brass/laiton mat	195 87202	48,00
		nickel-glanz/polished nickel/nickel brillant	195 87203	58,00
		nickel-matt/brushed nickel/nickel mat	195 87204	58,00
		schwarz-brüniert/black gunmetal/noir bruni	195 87206	58,00

	Como Raffrosette/holdback/rosette de drapage			
	12 cm	natur/natural/naturel	160 80002	15,00
		kirsche/cherry wood/merisier	160 80004	15,00
		eiche-rustikal/antique oak/chêne antique	160 80006	15,00
		nussbaum/walnut/noyer	160 80007	15,00
		weiss-lackiert/white lacquered/blanc laqué	160 80020	18,00
	Regency Raffhaken/drapery hook/crochet de drapage			
	2,9 cm	messing-glanz/polished brass/laiton brillant	195 52201	9,00
		messing-matt/brushed brass/laiton mat	195 52202	9,00
		nickel-glanz/polished nickel/nickel brillant	195 52203	12,00
		nickel-matt/brushed nickel/nickel mat	195 52204	12,00
		schwarz/black/noir	195 52213	9,00
		rost/rust/rouille	195 52259	9,00
		silber/silver/argent	195 52274	9,00
		eisen/iron/fer	195 52281	9,00
		sterlingsilber/sterling silver/argent sterling	195 52790	9,00
	Raffrosettenhaken/drapery hook/crochet de drapage			
	à 2	messing-glanz/polished brass/laiton brillant	679 52201	1,80
		messing-matt/brushed brass/laiton mat	679 52202	1,80
		nickel-glanz/polished nickel/nickel brillant	679 52203	2,75
		nickel-matt/brushed nickel/nickel mat	679 52204	2,75
	Großring/large ring/grand anneau			
	90 x 56 mm	edelstahl/stainless steel/acier inoxydable	00 09661	3,50
	Trägerstütze/bracket support/jambes de force			
	150 - 250 mm	messing-glanz/polished brass/laiton brillant	49 24201	115,00
		messing-matt/brushed brass/laiton mat	49 24202	120,00
		nickel-glanz/polished nickel/nickel brillant	49 24203	120,00
		nickel-matt/brushed nickel/nickel mat	49 24204	125,00
		schwarz-brüniert/black gunmetal/noir bruni	49 24206	120,00
		schwarz/black/noir	49 24213	115,00
	rost/rust/rouille	49 24259	115,00	

Edelstahl-Schleuderstab/stainless steel draw rod (baton)/lance-rideau (baton) en acier inoxydable			
100 cm	edelstahl/stainless steel/acier inoxydable	95 7166110	28,00
125 cm	edelstahl/stainless steel/acier inoxydable	95 7166112	32,00



Messing-Schleuderstab/brass draw rod (baton)/lance-rideau (baton) en laiton			
100 cm	messing-glanz/polished brass/laiton brillant	96 7160110	42,00
125 cm	messing-glanz/polished brass/laiton brillant	96 7160112	46,00
150 cm	messing-glanz/polished brass/laiton brillant	96 7160115	56,00
175 cm	messing-glanz/polished brass/laiton brillant	96 7160117	62,00



Aluminium-Schleuderstab/aluminium draw rod (baton)/lance-rideau (baton) en aluminium			
100 cm	weiss/white/blanc	95 7160510	42,00
	silber/silver/argent	95 7165510	42,00
125 cm	weiss/white/blanc	95 7160512	45,00
	silber/silver/argent	95 7165512	45,00
150 cm	weiss/white/blanc	95 7160515	48,00
	silber/silver/argent	95 7165515	48,00
175 cm	weiss/white/blanc	95 7160517	52,00
	silber/silver/argent	95 7165517	52,00



Stahl-Schleuderstab/steel draw rod (baton)/lance-rideau (baton) en acier			
75 cm	weiss/white/blanc	96 7160507	2,30
100 cm	weiss/white/blanc	96 7160510	2,60
125 cm	weiss/white/blanc	96 7160512	2,90
150 cm	weiss/white/blanc	96 7160515	3,30



Plexiglas-Schleuderstab mit Stahleinlage/lucite draw rod (baton) with steel insert/lance-rideau (baton) en acrylique avec insert en acier			
75 cm	glasklar/transparent/transparent	96 7144007	6,00
100 cm	glasklar/transparent/transparent	96 7144010	6,50
125 cm	glasklar/transparent/transparent	96 7144012	7,00
150 cm	glasklar/transparent/transparent	96 7144015	8,20



pflege- und gebrauchshinweise

instructions for care and use/instructions de soin et d'utilisation

Staubablagerung auf Ihrer Vorhangstange beeinträchtigt mit der Zeit die Gleitfähigkeit der Ringe und könnte die Oberfläche der Vorhanggarnitur beim Bedienen der Dekoration verkratzen.

Die Oberfläche sollte regelmäßig mit einem Staub- oder feuchten Tuch behandelt werden. Zusätzlich kann durch Einsatz von speziellen Pflegemitteln die gleichbleibende Veredelung der Oberflächen erhalten werden.

Salz-, chlor- oder nitrathaltige Umgebungsluft kann die Oberflächenversiegelung im Laufe der Zeit angreifen. Dies ist kein Reklamationsgrund.

The build-up of dust on your curtain pole gradually impairs the sliding of the rings and could scratch the surface of the curtain rod set upon handling of the curtains.

The surface should be regularly treated by using a duster or a damp cloth. The finish of the surfaces may also be maintained by using special cleaning products.

Salt, chlorine or nitrate-containing ambient air can damage the sealing surface over time. This is no reason for rejection.

Dépôt de poussière sur votre tringle entrave graduellement la glisse des anneaux et pourrait rayer la surface de tringle en manœuvrant les rideaux.

La surface devrait être traitée régulièrement avec un essuie-meubles ou avec un tissu moite. De plus on peut maintenir le raffinement constant des surfaces en employant des produits d'entretien spéciaux.

Air de l'environnement contenant sel, chlore ou nitrate peut corroder le scellement de surface au fil de temps. Cela n'est pas une raison de réclamation.

Innenlaufgarnituren/curtain rail sets/rails intérieur

Silikonspray erhöht die Laufeigenschaft beim Einsatz von Gleitern und verringert die Geräuschentwicklung beim Bedienen der Dekoration.

Silicone spray improves the running ability when sliders are used and reduces the noise upon handling of the curtains.

Spray de silicone améliore la capacité courante si on utilise des glisseurs et réduit le niveau sonore en manœuvrant les rideaux.

Vorhangstangen aus Edelstahl/stainless steel curtain poles/tringles en acier inoxydable

Pflegespray schützt die Oberfläche und bewahrt die Eleganz der Vorhangstange.

Unter Verwendung von Ringen mit Gleiteinlage wird die Geräuschentwicklung beim Bedienen der Dekoration zusätzlich verringert.

Care spray protects the surface and retains the elegance of the curtain pole. The noise upon handling the curtains is additionally reduced by using rings with a sliding insert.

Spray soignant protège la surface et préserve l'élégance de la tringle. En utilisant des anneaux avec insert le niveau sonore pendant manœuvrer les rideaux sera réduit.

Vorhangstangen aus Messing/brass curtain poles/tringles en laiton

Pflegespray schützt die Oberfläche und bewahrt die Eleganz der Vorhangstange.

Unter Verwendung von Ringen mit Gleiteinlage wird die Geräuschentwicklung beim Bedienen der Dekoration zusätzlich verringert.

Care spray protects the surface and retains the elegance of the curtain pole.

The noise upon handling the curtains is additionally reduced by using rings with a sliding insert.

Spray soignant protège la surface et préserve l'élégance de la tringle. En utilisant des anneaux avec insert le niveau sonore pendant manœuvrer les rideaux sera réduit.

Allgemeine Geschäftsbedingungen/ General terms and conditions/ Conditions générales

Unsere Lieferungen und Leistungen erfolgen ausschließlich zu unseren allgemeinen Geschäftsbedingungen. Diese erhalten Sie über unseren Verkauf oder unter www.prade-wohnakzente.de.

Our deliveries and services take place exclusively to our general terms and conditions. These you can get by our sales department or on www.prade-wohnakzente.de.

Nos livraisons et services s'effectuent exclusivement à nos conditions générales.

Vous pouvez les apprendre par notre département de vente ou par notre site www.prade-wohnakzente.de.